

National RADIO-TV NEWS

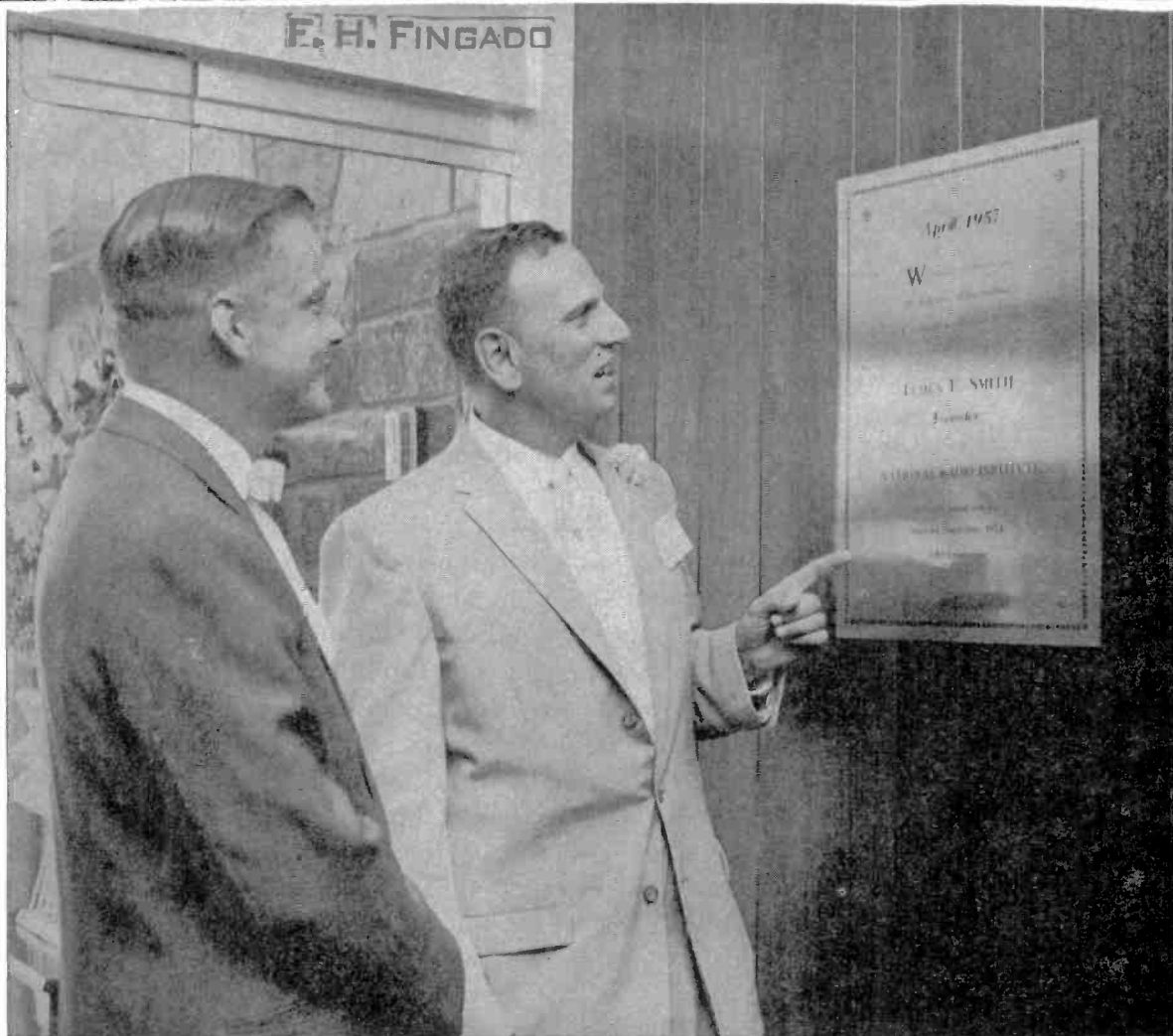

E. H. FINGADO



IN THIS ISSUE

NRI Holds "Open House"

Building a Free Power Receiver

Servicing Printed Circuit Receivers

Aug.-Sept.
1957

VOL. 17
No. 10



Get Rid of Your Negatives

A book appeared not long ago about the good effects of "positive" thinking and the harmful results of "negative" thinking. (Medicine has gone even further. This principle is the basis of the newest and most advanced branch of medical science, the study and treatment of physical illness caused by tension, worry and emotional distress.)

The book must have met a long-felt need of many people, for it has become a famous best seller. The substance of it is that our life experiences tend to follow and be determined by our mental attitudes. When we confidently and resolutely *think* health and happiness and success, then *by* our thinking we help create the conditions that will bring us health, happiness and success. But if we constantly depress ourselves with thoughts of failure, misery and misfortune, then that's what we'll get.

The lesson is plain. Once you have fixed a goal in whatever you undertake, make sure that every thought you think and every act you perform is on the positive side. Determinedly refuse to entertain any thought that does not contribute toward your goal.

In other words, get rid of your negatives.

J. E. SMITH, *Founder*

NATIONAL RADIO-TV NEWS

Theodore E. Rose, *Editor*
J. F. Thompson, *Associate Editor*
J. B. Straughn, *Technical Editor*
L. L. Menne, *Editor Emeritus*

Published every other month by the National Radio Institute, 3939 Wisconsin Ave., N.W., Washington 16, D. C.
Subscription, \$1.00 a year. Printed in U. S. A. Second-class mail privileges authorized at Washington, D. C.

NRI HOLDS "OPEN HOUSE"

On Friday, June 28, 1957, beginning at two in the afternoon, NRI proudly opened its doors and gave hundreds of guests a really close look at our new Wisconsin Avenue home.

Nothing was overlooked in preparation for this gala event. For that final touch, our lobby, offices, and all departments were decorated with many beautiful floral arrangements sent by well-wishers. Carnations and corsages were the "trimmings" for NRI employees who served as hosts and hostesses.

As guests arrived at NRI, many from far distant cities and states, they were greeted at the door by a Reception Committee of J. M. Smith, our President, Ted Rose, Director of the Graduate Service Department and Executive Secretary of the NRI Alumni Association, and Albert Doig, Manager, Mailing Division.

Our hat's off to the employees who served as guides in escorting groups of visitors through the entire building, explaining the operation of each department and answering questions.

Guests who arrived before 5 P. M. had the opportunity to see the Institute in operation and many expressed amazement at the equipment, modern methods, details, and processes involved in serving our students and graduates.

Each "tour" began on the third floor where guides were able to inspect the Central Typing Division, Instruction Department, Consultation Service, Lesson Grading, Conference Room, laboratories, and one of three stockrooms. Then to the second floor and the Student Service Department, Graduate Service, Alumni Association Headquarters, Accounting Department, Advertising Department, Purchasing Department, Filing and In-Mail Section, Executives Offices, and second-floor stockroom. On the first floor, guests saw the Printing Section, Out-Mail Section, Addressograph Section, Kit Packing Section, Shipping and Receiving, and additional stock.

Interested male guests (and some of the ladies too) were shown through our penthouse where the air-conditioning, heating, electrical and elevator equipment is housed. This part of the tour proved to be a fascinating experience as it is difficult for the layman to imagine the amount of complex and over-sized machinery needed to provide comfort in a building of this size.

Our beloved Founder, J. E. Smith, and Mrs. Smith were on hand to meet guests and renew acquaintances with friends, business associates and graduates of years gone by. Mr. Smith personally conducted several groups through the building and some of the younger fellows were frank to admit they had trouble keeping up with him. Mr. E. L. Degener, NRI's Secretary, Treasurer and General Manager also seemed to be in several places at the same time, showing folks around and giving information whenever needed.

The last step of each escorted tour was the basement which provides comfortable parking for over fifty employees' automobiles. For the occasion the area was cleared and decorated with palms, tables were set up and a buffet supper was served. Some of the items were hors d'oeuvres, canapes with caviar, cocktail rolls, finger sandwiches, bouchers, French pastries, fruit punch, and coffee.

Later in the evening employees made special tours with their families and friends. Our guides walked what seemed like miles and gave numerous talks but we believe the tired feet and hoarse voices were overcome by a strong sense of pride in being a part of NRI. You may be sure that any employee will be happy to give a similar tour to any student or graduate who stops in for a visit while in Washington.

A photographer was on hand during the entire Open House to catch a number of good shots, some of which appear on the following pages.



In our conference room, left to right; Ted Rose, Executive Secretary NRIAA; John Babcock, Vice-President NRIAA also Chairman of the Minneapolis-St. Paul Chapter; Earl Oliver, Vice-President NRIAA and Member of the Detroit Chapter; J. E. Smith; J. M. Smith; Joseph Stocker, Vice-President NRIAA; William Fox, Vice-President NRIAA, Member New York City Chapter; Lyman Brown, Member NRIAA and Technical Advisor to Springfield, Mass. Chapter. The loving cup shown was presented to NRI in 1929 by the Charter Members of the Alumni Association.

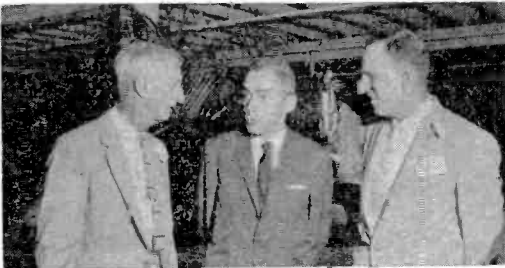

J. E. Smith and J. M. Smith chat with Mr. M. Harvey Gernsback (center) well-known as the Editorial Director of Radio-Electronics magazine.

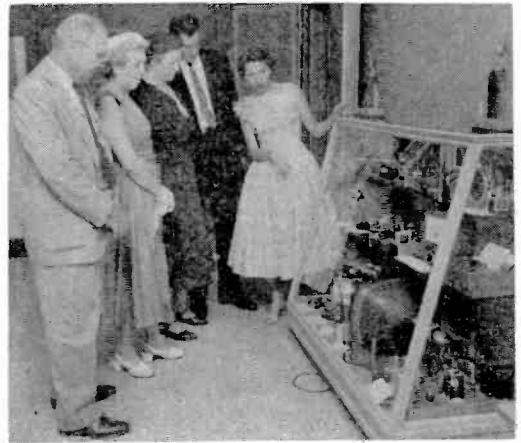

Millie Whitney, Central Typing Section, shows guests a display case containing assembled "kits" from NRI Courses.



(Left) Mr. Ed Boch (left) Assistant Manager Mailing Division, explains our Addressograph filing system to the Postmaster, Assistant Postmaster and others from the Washington, D. C. Post Office.



A group inspects the Quality Control Laboratory as Bill Roche, (Right) Student Service Consultant, explains its functions. Second from right is Mrs. J. E. Smith.



Miss Claire Porter, (right) In-Mail Section, shows a group of visitors through one of the three stockrooms. She displays an NRI pennant.



(Lower left) Jules Cohen, Secretary of the Philadelphia-Camden Chapter is served a cup of fruit punch while fellow Chapter member Adolph Stribeny and Lyman Brown, Technical Advisor, Springfield Chapter, eagerly wait their turn.



A few guests and employees gather in J. E. Smith's office during a tour. Third from left is Mrs. Ida Maloy, Mr. Smith's secretary.



George Mays (left) Building Superintendent giving a run down on the control panel which regulates the heating and air conditioning system throughout our building.

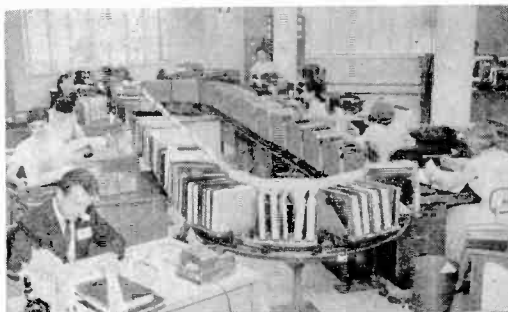

Partial view of the Student Service Department.

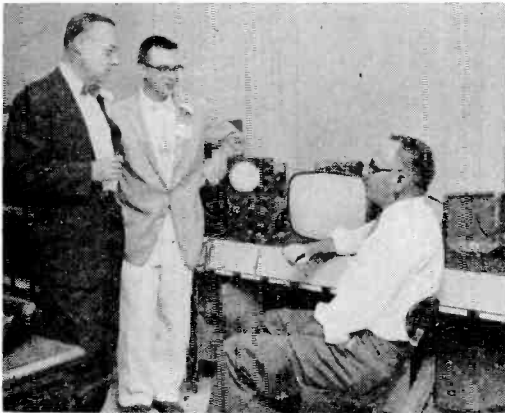

J. B. Straughn (left) Chief of Consultation, talks with Consultants Jack Dodgson (center) and Tom Carswell (right) while awaiting the next group of visitors to inspect a laboratory.



J. E. Smith conducting a "tour" through our fireproof vault where student and graduate records are stored for safe keeping. He is examining a student record dating back to 1926.

(Below) Our Accounting Section.



(Lower left) Part of the Central Typing Section where dozens of letters are prepared for Students and Graduates each day.

— n r i —

TUBE BASE MOUNTED SILICON RECTIFIERS SERVE AS REPLACEMENTS FOR CERTAIN VACUUM TUBE RECTIFIERS

Silicon rectifier power diodes developed by International Rectifier Corporation have made a strong entry into the electronics field in the past twelve months. In the light of the many apparent advantages available through the use of silicon every conceivable rectifier circuit is being re-evaluated.

The widespread success of silicon power diodes in high temperature applications has caused an immediate result in considering many requests to design and package rectifier units for direct replacement in existing circuitry. From an extensive background in packaging and engineering rectifiers for special applications, International Rectifier Corporation is able to select the most reliable design.

An interesting example is the direct replacement of the 6x4 full-wave high vacuum rectifier tube with International Rectifier Corporation's silicon plug-in equivalent, part number S6x4. In most applications this silicon plug-in rectifier will give direct advantages in savings on filament power supply, heat dissipation, long life and resistance to vibration and shock over the 6x4. Thorough testing over a wide range of temperature and environmental conditions indicate extreme reliability for the design characteristics and maximum stability is realized under all mounting positions.

BUILDING A 'FREE POWER' RECEIVER

By LEO M. CONNER,

NRI Consultant

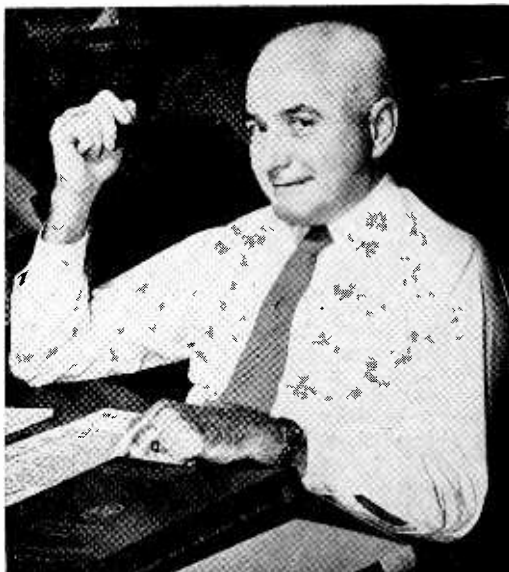

Leo M. Conner

The possibility of getting free power to operate a receiver, or other electronic device, is an interesting one and, over a period of years, many people have worked on the idea.

However, except for a few "stunts," free power never became a reality until transistors were developed. Transistors require low operating voltage and their current requirements are so small that ordinary flashlight cells will last almost as long as their shelf life. Eventually, however, the battery must be replaced so that there is some operating cost and we do not have free power.

In order to have free power, we need a source that requires no replacement and is readily available. Such a source of free power is the broadcast station carriers that are on the air continuously, day in and day out. These carriers are ac in nature and the only difference between them and the current supplied by the power company is the frequency and magnitude.

Instead of 25, 40, 50 or 60 cycles, the carrier frequencies are from 500,000 cycles (500 kc) to 1,500,000 cycles (1500 kc). The magnitude may vary from a millivolt or so up to several volts at locations near the antenna of a high powered transmitter.

However, it is not possible to erect an antenna and "pick off" this voltage. The amount of voltage available is too small and it must be increased before it is usable. A transformer, such

as those used in regular power supplies, is not suitable because it would have too much loss. How then, can we step up the signal voltage to a reasonable value?

A resonant circuit is the answer, since it will permit us to select the highest carrier voltage and provide resonant voltage step-up. To see how this happens, let us review some of the resonant circuit theory.

Fig. 1 shows a series resonant circuit. The frequency of the source voltage is shown as 700 kc but any AM broadcast carrier frequency may be used. The circuit action will be the same regardless of frequency.

When the coil and capacitor are adjusted so the circuit is at resonance, the reactance of the coil is exactly equal and opposite to the reactance of the capacitor so the two reactances cancel. Since there is no effective reactance in the circuit, there is nothing left to limit the flow of current but the resistance of the coil. Since the resistance of a well designed coil is very small,

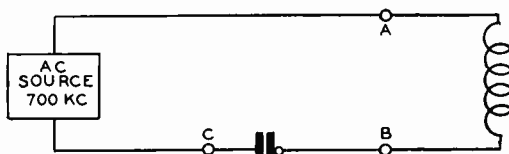

FIG. 1. A series resonant circuit.

the current through the circuit can rise to a relatively high value.

Since the same current flows in all parts of a series circuit, the current flowing through the reactances of the coil and capacitor will produce a correspondingly large voltage drop across these parts. The voltage, at resonance, across either the coil or capacitor will be several times the source voltage.

The voltage can be measured with a suitable instrument (vtvm) connected to either A and B or B and C. If, however, you connect the meter to A and C, there would be no voltage because the voltage drops, across the coil and capacitor being equal and opposite.

We can take the stepped-up voltage from either A and B or B and C and feed it to a rectifier. Since low currents will be used, a regular germanium diode (1N34) may be used as a rectifier. The output of the rectifier will be pulsating dc but, because of the high ripple frequency, it is easily filtered. A high capacity, low voltage electrolytic capacitor serves as the filter.

The capacitor terminals serve as the output terminals for the power section which is shown schematically in Fig. 2. The dc voltage across the capacitor may be measured with any good grade vtm and the tuning set for the desired dc voltage. Regular dc voltmeters are not suitable for measuring the voltage because they load the circuit too much.

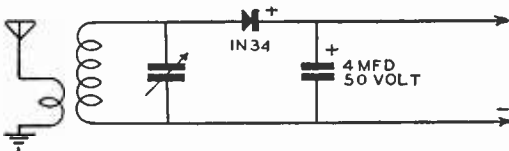

FIG. 2. Power supply circuit for rectifying and filtering an rf carrier.

Although a power supply of this type will enable one to obtain power from the air, the space required by the tuned circuit is as great as that required by batteries. In most cases, a long antenna is needed. The antenna should be between 50 and 100 feet long and as high as possible. In strong signal areas, it might be possible to use a short indoor antenna. The amount of antenna required will be determined entirely by the strength of the carrier signal. If the dc output of the power section is less than 6 volts, it will be necessary to use a longer antenna or tune to a stronger station.

In order to get greater selectivity, the "information" section of the receiver uses two tuned circuits as shown in Fig. 4. The diode detector (1N34) is followed by a transistor amplifier. The

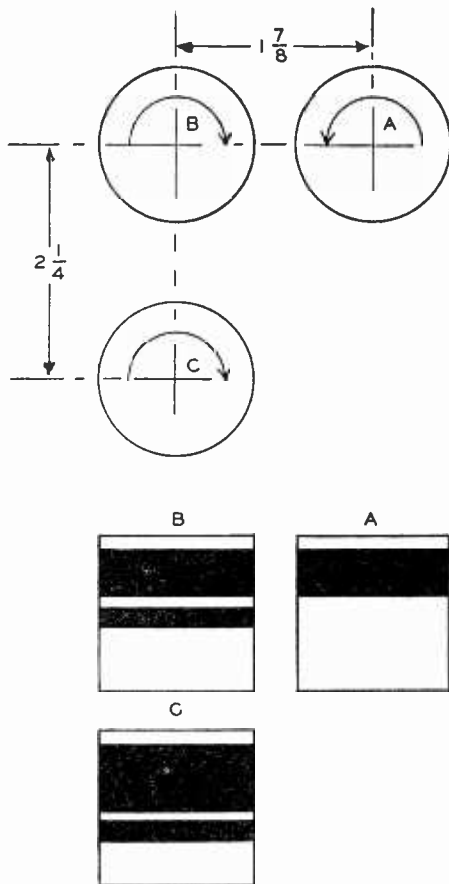

FIG. 3. Coil spacing and winding data.

transistor may be a type CK722, CK721 or 2N771. All of these are PNP types.

The coils are not available as standard items and it will be necessary for the builder to wind his own coils. Fig. 3 shows the coil winding information. Note that coil A is wound in a direction opposite to that used for coils B and C and that the winding is tapped.

All coils are wound on 1½-inch diameter tubing and each coil form is 1½ inches long. The tubing may be a section of cardboard mailing tube, or regular fiber or bakelite tubing may be used. Some firms stock regular 1½-inch diameter coil forms.

If cardboard tubing is used, it should be given two coats of shellac, inside and out, to prevent moisture absorption. Let the first coat dry thor-

oughly before you apply the second coat.

Many people have never wound coils and do not know how to go about the job. For these people, we will outline a method which works well and enables one person to wind a coil with a minimum of trouble.

The first step is to fasten the terminals to the coil form. Solder lugs are used and each lug is held to the form with a 6-32 x 1/4 inch machine screw and nut. For best appearance, the lugs should be spaced evenly around the form. The lug locations should be marked at one end of the form, the screw hole drilled through the wall of the form and the lugs bolted to the form below before starting the winding. Keep the lug mounting screws as near one end of the form as possible.

No. 34 enameled wire is used for the coils and since this wire is fragile, care must be taken to avoid breakage. Since it is almost impossible to hold a spool of wire in one hand and wind a coil with the other hand, a small winding jig was made up. This jig is composed of a 1/4-inch dowel rod and two rubber grommets. The dowel rod is first clamped in a vise or some other holding means and a rubber grommet pushed on the rod and up against the vise. A 1/4-lb. spool of wire is then put on the rod and pushed up against the grommet. The second grommet is then put on the rod and pushed up against the spool. The friction between the rubber grommets and the spool will provide a "braking" action on the spool and give enough tension to enable you to wind the wire tightly. Use only enough tension to keep the wire taut. If the grommet does not fit the dowel rod tight enough, use a small "C" clamp to hold the grommet in place.

Before starting to wind the wire on the form, holes should be drilled or punched at the correct points for the wire to be brought out to the lugs. If a cardboard coil form has been used, a needle may be used to make the holes. A No. 60 drill is suitable for making holes in other type forms.

Since coil A is tapped, we will give instructions for winding it first. This coil has three lugs.

The end of the form opposite the lugs is the starting end. At a point 1/8 inch from this end and in line with one of the lugs, drill or punch a hole. At a point 5/16 inch in from the end and in line with the next lug around the coil, drill or punch another hole. The last hole is 9/16 inch in from the end and in line with the last lug on the form.

When the forms have been drilled in this manner, it is not necessary to actually count the turns as the hole spacing has been calculated.

It is only correct for No. 34 enameled wire.

Use a piece of fine grain sandpaper to clean the enamel off the end of the wire. Then start the wire through the hole nearest the lugs. Pull the wire through the hole and out the end of the form. Then wrap the bare wire around the lug and solder.

Hold the form in both hands and take up the slack in the wire between the form and the spool. Start turning the form and the wire will wind itself around the form. Keep the turns close together and wind the wire on the form until you come to the next hole. The tap is to be made at this point.

Let go of the coil form with one hand while you hold the tension on the wire with the other hand. Then grasp the wound part of the coil with your free hand to keep the wire from coming loose. Allow about 6 inches of wire for the tap and fold the wire sharply. This will give a doubled wire and the doubled end should be put through the hole and pulled out the end of the form. Wrap the doubled wire around the lug to hold it tight but do not remove insulation at this time.

Continue winding the coil in the same direction until you come to the last hole on the form. Allow enough wire for connection and cut the wire. Feed the end through the hole and up to the lug. Remove the enamel and wrap the bare wire around the lug. Solder the connection.

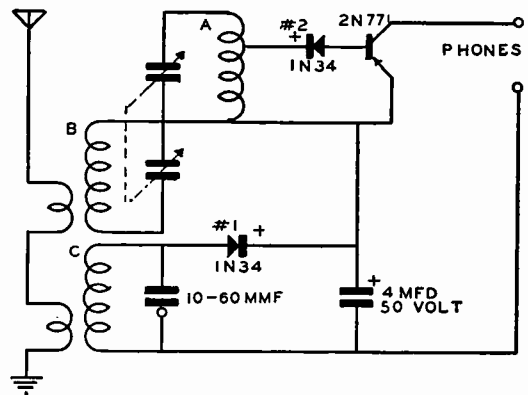

FIG. 4. Complete schematic of "Free Power" receiver.

Now, go back to the tap and unwind the enamel wire from the lug. Remove the insulation from both wires and then wrap them around the lug. Solder the connection. This completes coil A. If desired, the winding can be coated with coil "dope" to hold the turns in place and protect the winding.

Coils B and C each have four terminals. Neither of these coils is tapped and both have two separate windings. In locating the lugs on these coils, space them evenly around the diameter and keep the coil terminal lug mounting screws as close to one end of the form as possible.

These two coils are to be wound in opposite directions to coil A. Therefore, if you turned coil A toward you during the winding, turn coils B and C away from you while they are being wound.

For coil B, drill a hole $\frac{1}{8}$ inch in from the end opposite the lugs and in line with one of the lugs. The second hole should be $\frac{9}{16}$ inch in from the end of the coil and in line with the next lug. Remember the direction of winding is to be reversed.

The third hole should be in line with the third lug and $\frac{11}{16}$ inch in from the end of the form. The last hole should be in line with the fourth lug and $\frac{1}{8}$ inch in from the end.

The coil should be started by sanding the insulation off the end and pushing the end through the hole nearest the lugs. Wrap the bare wire around the lug and solder the connection. Start winding the coil and remember to wind in a direction opposite to that used for coil A. When you come to the hole, hold the wire you have wound on the form to keep it from unwinding and cut the wire about 4 inches from the form. Feed the wire into the hole and then pull it out the lug end of the form. Scrape away the insulation and wrap the bare wire around the lug. Solder the connection. This winding is the primary and when you have soldered the terminals, start winding the secondary. Be sure to wind the secondary in the same direction as the primary. The procedure for winding the secondary is exactly the same as for the primary except that the secondary has more turns.

Coil C has four terminals and they should be installed in the same manner as the terminals for coil B. The spacing of the holes for the leads is different. The first hole should be drilled $\frac{1}{8}$ inch in from the end of the coil and in line with one of the lugs. The second hole should be drilled $\frac{13}{16}$ inch in from the end and in line with the second lug. Remember to wind this coil in the same direction as coil B. The third hole should be $\frac{1}{8}$ inch from the end and in line with the third lug. The last hole should be $\frac{11}{16}$ inches from the end and in line with the fourth lug.

This coil should be wound in the same manner as coil B and when all coils are finished you are ready to start wiring the circuit.

The circuit is shown in Fig. 4. The tuning capacitors for coils A and B are the sections of a two-section, 365-mmf per section, TRF tuning

capacitor. The rotors of these sections are common and connect to the frame of the capacitor. Note the connections to the capacitor very carefully. The end of coil A that is farthest from the tap should be connected to the frame of the capacitor and the end of coil B that is farthest from the lugs should be connected to the capacitor frame. Coil C is tuned by a trimmer type capacitor.

The receiver may be assembled on a wooden baseboard. The most important part is to space the coil centers as shown on the coil drawing. The coils may be secured to the baseboard by means of wood plugs, whittled to fit the end of the form and fastened to the baseboard with brads or screws. Be sure to follow the recommended spacing.

The tuning capacitor should be mounted close to coils A and B. Locate the end of the secondary winding of coil B that is not connected to the capacitor frame and connect this lead to one stator terminal. Connect the other stator terminal to the end of winding A. The top on coil A should be connected to the + terminal of the #2 1N34 diode.

The primaries of coils B and C should be connected in series. Care must be used in making the connections to these windings. Locate the end of the primary on coil B that is nearest the secondary winding. This end should be connected to the antenna. The other end of this coil should be connected to the end of the primary on coil C that is nearest the secondary. The remaining primary lead on coil C is the ground connection.

The end of coil C secondary that is nearest the primary winding should be connected to one trimmer capacitor terminal, the negative terminal of the 4-mfd capacitor and one headphone terminal. The other end of the coil C secondary winding should be connected to the second trimmer connection and the negative lead of diode #1. The positive #1 diode lead should be connected to the positive electrolytic capacitor lead and the frame of the tuning capacitors. The Emitter of the transistor is also connected to the frame of the tuning capacitor.

The Base of the transistor is connected to the negative lead from the #2 diode while the Collector of the transistor is connected to the phones. Fig. 5 shows the transistor symbol and a pictorial drawing which shows the terminal arrangement.

Operating the Receiver

As mentioned previously, a long OUTSIDE antenna must be used in most locations. Do not try to operate the set from a short antenna. If at all possible, use a water pipe ground. If no

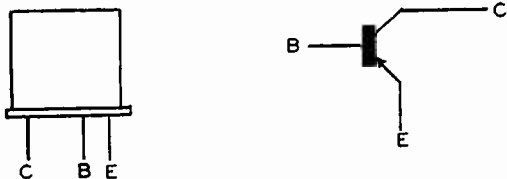

FIG. 5. PNP transistor connections.

water pipe ground is available, use a regular ground rod at least 6 feet long.

After the antenna and ground have been connected, connect a pair of MAGNETIC headphones to the set. Do not attempt to use crystal headphones because they have high impedance.

Choose a strong local station and turn the power section to its frequency. To do this, connect a vtvm across the electrolytic capacitor terminals and tune the trimmer until approximately 6 volts appears across the capacitor. Then tune in a station with the tuning capacitor.

The same station may be used for both power and entertainment. Once the power section is tuned to a station which provides satisfactory voltage, it need not be retuned.

This set is a simple means of demonstrating how the operating voltage for transistors may be obtained by rectifying and filtering the carrier signal of a standard broadcast station. The power obtained in this manner can be used to operate other transistor devices such as single transistor audio oscillators and if higher voltages are needed, it is possible to connect additional power sections and tune each section to a different station. The outputs of the power sections can be connected in series.

NRI cannot supply any of the parts needed for this receiver. However, they may be obtained from mail order firms such as the Allied Radio Corporation, 100 N. Western Ave., Chicago 80, Illinois.

Parts List for "Free Power" Receiver

- 1—PNP (CK722, CK721 or 2N771) transistor
- 1—2-section, 365-mmf per section, tuning capacitor
- 2—1N34 germanium diodes
- 1—10-60 mmf trimmer capacitor
- 1—4-mfd, 50V, electrolytic capacitor
- 1—pair magnetic headphones
- 3—1½" x 1½" coil forms
- 1—¼ lb. spool #34 enameled wire
- 11—solder lugs
- 11—6-32 x ¼" machine screws
- 11—6-32 nuts
- 1—baseboard
- antenna and ground

Listen Americans!

by Dr. George S. Benson
Director, National Education Program

The people who make a profession of studying the economic health of the U.S.A. are predicting that prosperity likely will continue for some time, with very little if any interruption. This is welcome news to anyone who takes the time to read and digest it. All of us have a stake in the health of the nation's economy. And yet, how many of us really understand what makes prosperity?

If we had to describe the root force in our prosperity in one word, it would be "production." There are many other vital factors. But without continued expansion of production, which creates new wealth, our prosperity soon would wither and die. Purchasing power comes only through production. So a fundamentally important thing in our dynamic private enterprise economy—and our prosperity—is the creation of a productive job.

For a new job to be created someone must think up a new process, a new service, a new product, or expand a present one. A plan for a new process, a new service, or a new product must be drawn up and tested for usefulness and consumer acceptance. After these two initial steps have been taken, someone then must invest an average of \$12,000 in plant, tools and equipment to create each job. Today in America we must have more than a million new jobs a year to take care of our expanding work force, our growing population.

A million new jobs each year mean that \$12 billion in new wealth must be invested at \$12,000 per job on the average. Where does this money come from? It must come from people whose net income is more than their living expenses. If a single man spends only \$3,000 a year for living expenses, he must earn a total income of approximately \$25,000 to have \$12,000 left over to invest in a business enterprise so that one job can be created. This is something to think about.

After a job is created and a new company or expansion is in operation, it takes some doing to keep the job operating, the new production going. Tens of thousands of companies fail every year and many times that many jobs are destroyed. This gives additional importance to the millions of people who manage to earn enough to save a little to invest in American business and industry. It also emphasizes the importance of having efficient and economic government, at all levels, so that taxes don't eat up the earnings

(Page 18, please)



J. G. Dodgson

Servicing Printed Circuit Receivers

By JOHN G. DODGSON

NRI Consultant

Printed circuits, a development of recent years, are coming into great use in commercial radio and television receivers as well as in military and industrial equipment. The printed circuit process was developed mainly for economy in manufacturing—the performance in some ways is superior to normal wiring. So far as the serviceman is concerned, there are no major advantages to him personally and there may be some disadvantages. One minor advantage may be that there is less chance of wiring errors in manufacture. However, the repair of printed circuit receivers can cause the serviceman considerable trouble unless he uses the proper methods and tools.

There are two major types of printed circuits: The printed wiring type in which standard parts are used and are connected together by the "printed wiring," and the full-printed circuit which has resistors, condensers, and even coils and transformers made of printed materials.

Various methods are used to make printed circuits. In one, the manufacturer actually places the wiring of the circuit on a board made of Phenolic Plastic or some other insulating material. The wiring is "printed" on this insulating board, using "inks" which are conductive so that the thin lines of ink act as the wiring in the circuit. Another and perhaps the more popular method is often called the "Etched-Circuit" process in which the board is covered with a sheet of very thin copper foil which is securely cemented to the insulating board. Using a "template" of the circuit, the unwanted copper is then etched away with acid, leaving the wiring on the board. The end result, of course, is the same in both methods.

In the full printed circuit, all parts are printed

on the board. If a resistor is needed, ink of a different composition is used so that it will have the correct resistance. Condensers are made by printing a plate on either side of the board of the proper size, with the board itself acting as a dielectric. Coils are made by printing spirals of wire and if the transformer is needed, spirals of wires are printed on both sides of the board to provide coupling. Naturally, this type of coil or transformer is limited to only a very few turns because of the space which, of course, limits their use to high frequency circuits.

The printed circuits encountered by servicemen are usually of the type in which only the interconnecting wires are printed and normal resistors, condensers, and such parts are used. These parts are connected to the printed wiring by small holes or eyelets in the board. The printed wiring comes up to and through the

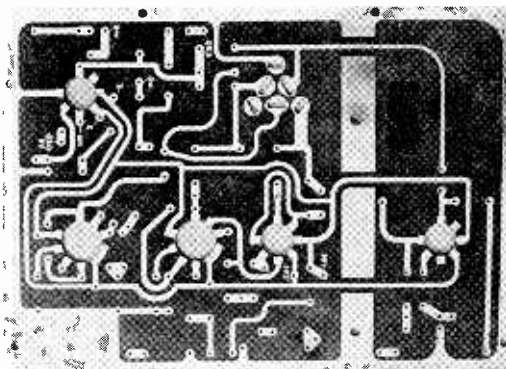

FIG. 1. The printed circuit chassis of a modern 5-tube superheterodyne.

holes just as in a riveted eyelet in an ordinary chassis. When all parts are mounted, they are soldered to the board by dipping the underside into a "solder-pot." There is obviously a great saving in time over the standard method of individual soldering of parts. Such printed circuits are typified by the modern 5-tube superheterodyne receiver shown in Figs. 1 and 2.

Trouble-shooting printed circuits receivers is little different than ordinary wired ones and the same instruments are used. Some difficulty

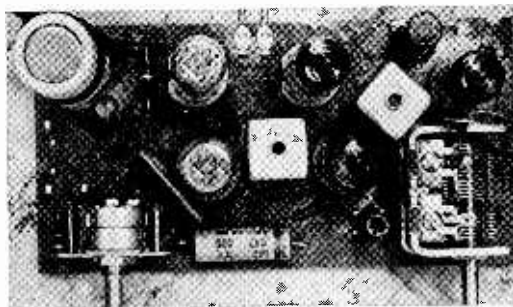

FIG. 2. The "parts side" of a typical printed circuit receiver.

may be encountered in attaching test probes since the usual tube socket lugs and terminal lugs are not used. In such cases, it is important to use sharp needle-point test prods and to apply these prods to joints rather than the wiring itself. It is often not possible to attach the test prods with clips to any soldered joint on the printed circuit board. However, it is sometimes possible to attach, say the negative test lead, to a resistor and condenser lead between the body of the part and where it is attached to the printed circuit board. A heavy probe should never be attached in this manner, since it may exert too much weight and thereby pull the lead right out of the board or at least weaken the joint.

Some difficulty may be encountered in tracing the wiring until the serviceman becomes familiar with these circuits. Since the inter-connection of parts takes place on one side of the board with all of the parts on the other side, it is often difficult to determine the location of parts. One "trick of the trade" is to place a light on the printed wiring side of the board by either using a flashlight or a goose-neck lamp. The wiring can then be seen from the "parts" side of the board since the insulating board is translucent. Conversely, the light can be placed on the "parts" side of the board and an outline of some of the various components (particularly the resistors and tubular capacitors) can then be seen from the wiring side of the board. Of course, when using this method, it is necessary to stand

the board on its edge if it is a radio or any other chassis that is normally horizontally mounted. With the modern vertical TV chassis, the board is already in the best position.

As mentioned previously, most of the test instruments used in normal servicing can also be used in printed circuit servicing, except for some limitations. Many of the transistor portable receivers use printed circuits to aid in miniaturizing. Since the transistors are very low-powered devices, there are a number of special components used which are not normally found in standard radio and TV circuits employing vacuum tubes. For example, the B battery in a transistor portable may be a 9-volt battery and thus many of the electrolytic condensers will have a rating of 10 volts while the resistors may be one-quarter watt or even smaller. Caution must be used when employing test instruments which may damage these parts. For example, the ohmmeter section of many volt-ohmmeters employ 22½-volt batteries which could destroy electrolytic condensers and may even burn up the small wattage resistors and ruin the transistors. Of course, these examples have little to do directly with the servicing of printed circuits although the damage of any parts will naturally necessitate their replacement.

When soldering in these printed circuit portables, it is often wise to remove transistors from their sockets to prevent heat from damaging them even when a small soldering iron is used.

There are some special hand tools available from most wholesalers that can be used for servicing printed circuits. Although, in a pinch, standard radio-TV servicing tools can be used, these special tools have been manufactured specifically for printed circuits and it is therefore wise to employ them since it will save time and enable a better job to be done.

First of all, it is essential that a smaller soldering iron than normal be used. Although soldering guns with heat capacities of several thousand degrees and rated up to 250 watts must be just ideal for television servicing, they can do a fine job of ruining a printed circuit board! Smaller soldering irons can be used successfully although it is best to use the pencil type irons offered by several manufacturers. These soldering pencils are available with various size elements. Those with ratings from 20 to 40 watts are best suited for printed circuit work. While on this subject, be sure to use the proper solder for printed circuits—thick solid solder is not suitable at all. Be sure that the solder is "RADIO" rosin core and preferably is the 60-40 type. That is, compounded of 60% lead and 40% tin. The maximum diameter should be 1/16 inch.

Just as important as the small soldering iron is

another small tool about eight inches long having a stiff wire brush on one end and a sharpened point on the other. This soldering aid tool is available from several manufacturers for under one dollar. More about its use later.

The serviceman's first printed circuit servicing job will probably be his most troublesome! As mentioned previously, trouble-shooting is just about the same as in regular wiring. However, once a serviceman has chased down the defective part, he is then faced with the problem of removing that part and replacing it. He may find that it is a special part for printed circuit wiring. For example, some paper capacitors designed for printed circuit wiring have both leads coming out of the same end so that the capacitor can be mounted on the "parts" side of the chassis standing up in the air like an i-f transformer or tube. The capacitors of this sort are not difficult to remove since there are only two leads to unsolder. To remove the unit, both leads must be loosened separately. Hold the soldering pencil tip on the lead connection to the printed circuit board until the solder melts. Then brush the solder away with the wire brush previously described. Be careful not to hold the iron on the board too long or the printed wiring which is bonded to the board may be lifted from the board. By continually heating and brushing, all of the solder can be removed quite easily. After removing the solder from one end by this method, the other lead can be treated in the same manner. However, it is not necessary to remove all the solder from the other lead. Merely hold the iron on the joint until the solder melts and then with the other hand, gently rock the capacitor back and forth until the lead loosens and can be removed.

Replacing the capacitor is easier than removing the defective one. However, with this type of capacitor it is desirable to have the same replacement type so far as its physical dimensions are concerned (as well as its electrical characteristics). If, however, such a capacitor is not available at the time, then a standard paper capacitor can be used. Since the leads come out separately in the standard paper capacitor, it is necessary to take one of the leads and bend it down across and in parallel with the capacitor body. The lead can then be held in place by wrapping a piece of plastic insulating tape around the lead and capacitor holding the lead in place. If available, a piece of spaghetti can be used on the lead where it touches the body of the capacitor to minimize the possibility of leakage. When this is done, both leads of the capacitor will then be projecting from one side as in the original part. Cut the leads to length and then carefully tin them before inserting them in the printed circuit. This cleaning and tinning of the leads cannot be over-emphasized.

If the solder was completely removed with the

brush technique described above, push the capacitor leads through the holes and then while holding it in place with one hand, apply the soldering iron to a piece of solder and then quickly touch it to the junction of one of the leads and its appropriate hole on the wiring side of the circuit board. This is not the most desirable soldering method but it is sometimes the only method since we only have two hands! Once one capacitor lead is "stuck" sufficiently to hold the capacitor in place, solder the other lead by heating it with the tip of the soldering iron and applying solder in the normal manner. Then, go back and resolder the first lead properly after the second one has cooled and finally, clip off the excess wire. After a careful inspection to see that no accidental short circuits have been caused, the job can be considered complete. Incidentally, the pointed end of the wire brush tool can be used to scrape away any excess solder on the joint or any solder that has dropped down the insulating board.

Removal of components having more than two terminals is a little more difficult than the capacitor described above. However, the same techniques are used—it just takes a little longer. For example, i-f transformers would have four or six lugs (depending on the type) and it would therefore be necessary to heat each terminal separately and brush away the solder until all, or at least all but the last, lug is loosened from the printed circuit board. It could be said that servicing printed circuits requires more patience than skill. Carelessness can certainly cause more trouble in printed circuit servicing than in normal wiring.

Sometimes it is impossible to brush away all of the solder and free the lead in a printed circuit. If this should happen with a capacitor, it would be necessary to hold the soldering iron on the joint and rock the capacitor as mentioned previously. This isn't too difficult with "two-lead" capacitors but can be very troublesome with four or six terminal i-f transformers.

However, most manufacturers have provided a little leeway in the circuit boards to aid in parts removal. That is, the holes in the boards are sufficiently large to permit considerable rocking. Do not be impatient or the result could easily be disastrous. If the component is rocked too roughly, the entire printed circuit board may crack which will in turn, break the printed wiring. This might necessitate the replacement of the entire circuit board which could be quite expensive. In addition to the expense, you may find a waiting period of from ten days to a month before the replacement board can be obtained from the dealers.

Of course, it is very often possible to repair such broken boards. The board itself can be fastened together with staples or by drilling small holes

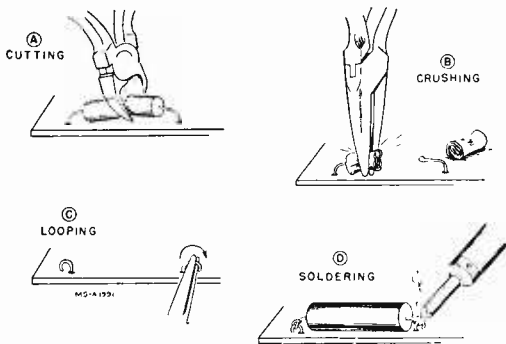

FIG. 3. One method of replacing parts in a printed circuit receiver. A, Cutting the part; B, Crushing the part; C, Looping the remaining leads; D, Soldering the new part into place.

and wiring it together. The broken wires can be repaired by different methods. The usual broken wiring in a circuit board is a very fine "hairline" break which, by the way, is often extremely difficult to locate. One reason for this difficulty is that applying the test prod to the printed wire may be sufficient pressure to push the broken ends together—emphasizing again the desirability of a thin needle-sharp test prod and a very delicate touch.

With hairline breaks, it is often possible to touch the hot soldering iron point on a piece of solder and then to the break. The small amount of solder on the tip may be enough to span the break. If, however, the break is larger, a piece of hook-up wire can be placed on top of the printed wire and soldered to it. Be sure to use thin wire and to tin it very carefully beforehand. Also tin the printed wire using as little solder as possible. With printed circuits and a pencil iron, you will often find the normal soldering process is not necessary. It is usually only necessary to touch the tip of the iron to the point to completely melt the solder. Again, be sure to use very thin solder with a 60-40 compound if possible.

Some manufacturers recommend coating such repairs with coil dope or insulating varnish. Such material is often included in printed circuit repair kits available from wholesalers. It is probably a matter of opinion whether or not this practice should be followed.

As in all other techniques, there are some short cuts in printed circuit servicing. For example, it is often possible to cut the leads of the defective resistor or condenser right at the body of the component. Then, the new part can be installed and soldered to the old leads. In other words, the replacement is done entirely from the parts side of the board without bothering with the

printed wiring at all. This method is highly recommended since it minimizes the possibility of damaging the printed wiring.

A similar process is suggested by RCA and is illustrated in Fig. 3. Notice in these illustrations that the component itself is cut in two and crushed instead of just the leads being cut. This is suggested since the leads from the component body to the printed circuit board are often only a fraction of an inch long. However, some difficulty will be encountered in cutting and crushing some components such as the plastic impregnated paper capacitors and the larger (in wattage) resistors. RCA also recommends replacing tube sockets in a similar manner as shown in Fig. 3. The author has tried the RCA recommended method for removing resistors and condensers and has found it successful in most instances. However, sometimes it was just as easy to remove the part and replace it in the normal manner by brushing away the solder as previously described. The removal of tube sockets as shown in Fig. 3 could only be successful with the wafer type socket. Even then, some difficulty may be encountered. Incidentally, when using this method of replacing either the resistors and condensers or the tube sockets, be sure that you do not exert any outward force on the parts which might bend and thereby break the circuit board or might cause the printed wiring to tear loose from the board.

Tube sockets can also be removed in the same manner as i-f transformers which was previously described. Of course, since there are seven, eight and nine pin tube sockets, more trouble is en-

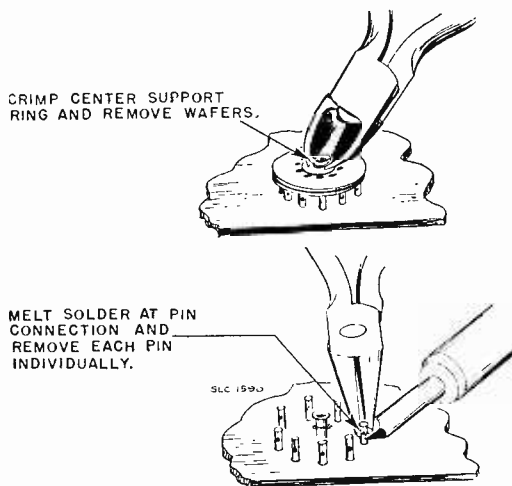

FIG. 4. Method of replacing a wafer type tube socket. A, Crimp the center support and remove the wafers; B, Melt solder at pin connection and remove each pin individually.

countered than with transformers. Fortunately it is not often necessary to replace tube sockets!

Experienced servicemen might be surprised at the lack of trouble in printed circuit receivers stemming from the printed circuit technique. Although considerable "poor connection" troubles were encountered in previous dip soldered chassis, printed circuits seem to be relatively free from this difficulty. Of course, some loose connections are encountered as in regularly wired sets and especially with portable receivers where they receive more abuse. Although the

— n r i —

SCIENTISTS EXPERIMENT WITH "SPOT WOBBLE"

The dark horizontal lines clearly visible in any "close up" look at a TV picture may someday be a thing of the past.

Scientists at the Westinghouse Research Laboratories have developed an experimental method for eliminating "scanning lines." Announcement of the new technique was made by Mr. Francis T. Thompson, Research Engineer at Westinghouse in an address to Society of Motion Picture and Television Engineers.

This method consists of splitting in half one of the tube's cylindrical metal grids used to focus its electron beam into a small round spot. It is said that the new technique employs a method of wobbling the beam vertically as it makes its repeated traces across the picture tube. The slight up-and-down motion of the beam broadens the white lines which carry the picture information and narrows the distracting black lines.

This technique is still in its experimental stages and has not yet been adopted on a commercial scale.

"Present television receivers are in sharpest focus and give maximum picture detail only when the horizontal scanning lines are themselves most distinct," Mr. Thompson said. "The average viewer, therefore, has come to associate the presence of these lines with a sharp, clear picture."

"With 'spot wobble' the viewer would have to become accustomed to a picture which gets rid of these lines without any loss of detail or resolution in the picture. Once accustomed to it, we think the average viewer would prefer larger television pictures which offer both low line structure and higher picture detail."

Certainly a step in the right direction toward an easier to see picture for millions of TV viewers.

Page Sixteen

author has had no experience with printed circuit automobile receivers, it can be expected that loose connections will be a more frequent complaint due to the natural abuse of these auto receivers. With everything considered, the servicing of printed circuits is not particularly difficult and, in fact, the change of pace may prove interesting. The most difficult job will be the first and after the first successful job, the serviceman will gain confidence. As pointed out before, and it cannot be over-emphasized, careful soldering and patience are the two most important ingredients.

— n r i —

OHIO STATION FIRST WITH "COLOR TV ON WHEELS"

TV Station WLWT of Cincinnati, Ohio is the first independent television broadcaster equipped to originate live, local color television programs from a roving "studio on wheels."

The color television unit, a complete mobile TV control room developed by RCA, is a streamlined van outfitted with video, audio and other equipment necessary for origination of colorcasts. It carries three color TV cameras that can be operated remotely from the van. The \$250,000 mobile unit is complete with air conditioning and heating equipment.

— n r i —



GOD BLESS MOM 'N DAD AND THE GUY THAT FIXES OUR TV...

SKYWAYS UNDER CONTROL

*Reprinted through the courtesy
of the
International Telephone and
Telegraph Corporation*



Photo Courtesy of W. K. Grace & Co.

Since the early days of international flying, airline passengers have been requested in two or more languages to fasten their seat belts and observe the No Smoking rule during take-off and landing. Loudspeaker announcements are also made in languages with which the majority of the passengers are familiar, but this same consideration has not been accorded the international airlines pilot on whom the safety of all aboard might well depend. Instead, when bringing his giant aircraft in at world airports, he is often required to follow landing instructions radioed from the ground in a language other than his own. Many pilots have had bilingual training, but under extreme pressure, misunderstanding may arise because of noise, distortion, or language difficulties. In fact, accidents have occurred in the past, which were ascribed to the inability of foreign pilots to comprehend instructions from the control tower.

Now, for the first time, this and other important air traffic control problems can be eliminated by means of a newly declassified electronic system known as the TACAN Automatic Reporting and Data Link, which was developed for the United States Navy by the Federal Telecommunication Laboratories division of International Telephone and Telegraph Corporation. The new system, which is the result of six years of research, represents a major advance in bringing air traffic control to a point where it can adequately handle today's high-speed aircraft and those projected for the future as well. It is designed to insure safety in flight, with particular emphasis on the control of air traffic in the congested air space over large terminals.

Compatible

Just last year a big step was taken in this

direction when FTL's TACAN air navigation system was combined with VOR (very high frequency omnirange) and standardized as VORTAC, the common civil and military navigation aid, which is now being broadly implemented by the Civil Aeronautics Administration and the U. S. Department of Defense. However, TACAN (or VORTAC), while it supplies the navigational information that enables a pilot to fly with complete accuracy to any destination, by itself helps very little to avert midair collisions or maintain orderly traffic in the vicinity of a busy airport. To do this, air traffic control centers must have automatic and accurate information on the identity, position, altitude, speed, and direction of travel of all aircraft in the controlled air space. The Data Link, which is fully compatible with both TACAN and VORTAC, offers this service. It has the added advantage of requiring no additional radio equipment and, therefore, there is no need to seek international agreements on new radio frequencies.

Loss of Time

Some effort has been made at policing the airways through the use of radar alone, but with all of its advantages, radar does not provide the means for positive identification of aircraft by ground personnel. The radar scope is not unlike a television screen. Instead of presenting a picture that is easily identifiable, however, it shows only spots or "blips," which indicate where the aircraft in question is located. Unfortunately, the ground controller has no way of associating a plane with its corresponding blip until he has been forced to use up precious minutes watching the spots for a period of time, and has maintained voice communication to ultimately determine course and speed.

Easily Located

FTL's new system employs a scope on which the radar spot is replaced by identifying numbers. The position of these numbers on a map represents the location of an airplane, one number indicates air speed, and an arrow passing through the numbers gives the direction in which the aircraft is headed. Equipped with this information, the ground controller has all the data he needs for making quick decisions. He can work out traffic control instructions himself, or it can be done in split seconds by electronic computers. The pilot is then given a safe course to follow over the TACAN Data Link, and he merely presses buttons to acknowledge receipt of, and compliance with, his instructions.

In six seconds or less, as many as 120 planes within a 200-mile radius can be serviced in this fashion by one ground station. Had the Data Link been available last year, the Grand Canyon collision of two airlines might well have been averted, because ground controllers would have been aware of the situation well in advance.

In order not to overload the aircraft's already crowded instrument panel, certain navigational orders are displayed on dual-purpose indicators, which show actual and ordered flight conditions. For example, the dials of the TACAN instruments give the pilot his bearing and distance from the ground station and, at the same time, the bearing and distance the air traffic controller has assigned. The same is true of other instruments, such as the air speed indicator and the altimeter.

Two new panel instruments enable the pilot and ground controller to exchange printed messages on routine matters through a unique push-button arrangement. Each has at his command



Airborne Equipment. This panel displays all the instruments and messages necessary for complete operation of the Data Link on board an aircraft. The operator is pointing out the bearing indicator,

Page Eighteen

a "library" of 31 prepared messages, such as "wheels down," "proceed," or "landing." These are transmitted simply by pushing the appropriate button in each case. As the order arrives in the aircraft, a signal calls it to the attention of the pilot who, for completely safe control, acknowledges the order by means of the proper push-button.

Since the message transmitted from the ground is displayed on the instrument panel of the plane in printed form, it can appear in English, French, German, Japanese, or any other language with which the pilot is familiar. Therefore, while freeing the overcrowded voice radio channels from the heavy load of routine reporting, the push-button feature has the added advantage of eliminating the language problems encountered in international flight.

Powerful Tool

The present major air traffic control problem stems from the phenomenal rise in air traffic in recent years and the extreme speeds at which many of today's planes operate. And, the condition can not help but be further aggravated by the introduction of commercial jet flights by 1960. In the TACAN Automatic Reporting and Data Link, which can safely handle the most complex traffic situations with ease, aviation authorities have a powerful tool for the development of the long-sought solution to the air traffic problem.

— — — — — n r i — — — — —

(Continued from Page 11)

of the masses of American workers and leave us without the vastly important investment capital so necessary to our improving economic welfare.

Healthy production and the creation of jobs began in America in the early 17th century, at Jamestown and Plymouth Colony, when the principles of private ownership, freedom of enterprise, and self reliance were established.

— — — — — n r i — — — — —

OUR COVER

J. M. Smith, President of NRI, points out the plaque commemorating the dedication of our new home to one of many guests during the recent Open House celebration. This plaque, placed near the main entrance where all may see it, reads, "April, 1957. We proudly commemorate the dedication of this building which we regard as a dynamic monument to the many and great accomplishments of JAMES E. SMITH Founder of the NATIONAL RADIO INSTITUTE our good friend and inspiring leader since 1914. NRI Employees."

Technical Ramblings

By B. VAN SUTPHIN

NRI Consultant

Subject: OHMMETER TESTS

In most service work, dynamic testing methods are best. That is, testing methods that can be carried out with the equipment turned on. Typical of these are voltmeter tests.

When the trouble is overheating of some component in the circuit, however, ohmmeter tests are necessary. These are carried out with the equipment turned off. Also, ohmmeter tests are required in checking continuity through resistors and transformers to confirm the defect, or to definitely decide when there is more than one possibility.

Fig. 1A shows part of the B supply circuit in an ac-dc receiver. The pictorial layout is shown in Fig. 1B.

Suppose that the rectifier tube, V5, is sparking internally and showing other signs of excessive current flow. How would you go about locating the short?

First, turn the set off and short the cathode (pin 8) of the rectifier tube, V5, to the B— point. Though it is unlikely that any charge would remain in the filter condensers, it is always a good idea to be sure that they are completely discharged before making ohmmeter tests.

With the ohmmeter set to a medium range, touch one probe to the receiver B— point and the remaining probe to the cathode of the rectifier tube. Suppose that the reading is 3500 ohms. Make a note of this.

Then transfer the ohmmeter probe from the cathode of the rectifier over to the other side of filter resistor R2. A convenient connection point is pin 6 of V1, referring to the pictorial. If no pictorial were available, it would be a simple matter of tracing the circuit.

Suppose that the reading is 2000 ohms. This proves that the short is on the "set side" of filter resistor R2. If the reading obtained in the second test had been higher than the reading in the first test, then this would prove that

the input filter condenser, C5 in the schematic, was shorted or leaking.

Continuing the testing, the next point to check is the plate of the audio amplifier tube, V4. Suppose that the reading at this point is 1800-ohms, lower than either of the previous readings. This proves that the audio plate bypass, C4, is shorted.

If the ohmmeter reading obtained at the plate of the audio output tube was higher than the reading obtained at the B+ point, then the output filter condenser, C6, is leaking, or there is leakage in some other component connected to the B+ circuit.

Now consider a problem where the B+ voltage is normal, but there is no plate voltage available at pin 5 of V2, again referring to Fig. 1. The most likely reason for this complaint is an open circuit in the primary of the second i-f transformer, L2. To check this, turn the set off and use your ohmmeter to check for continuity between the plate connection of the tube and the B+ line. If an open circuit reading is obtained, the transformer primary is definitely open. The transformer must be replaced.

Similar checks can be made of individual resistors in the equipment when it is necessary.

Fig. 2 shows a transformer-type power supply having a number of different output taps. With a complex circuit like this, there are a number of different components that could short and cause overloading of the rectifier tubes, but the testing method is exactly the same. Start at the B+ point—in this case, the filament of the rectifier—and check the resistance from there to ground. Then go to the other side of the first resistive element in the circuit, and again check. If the first reading is lower than the second, the input filter condenser is shorted. If the second reading is less than the first, the output filter condenser is shorted, or there is a short in the B+ circuit.

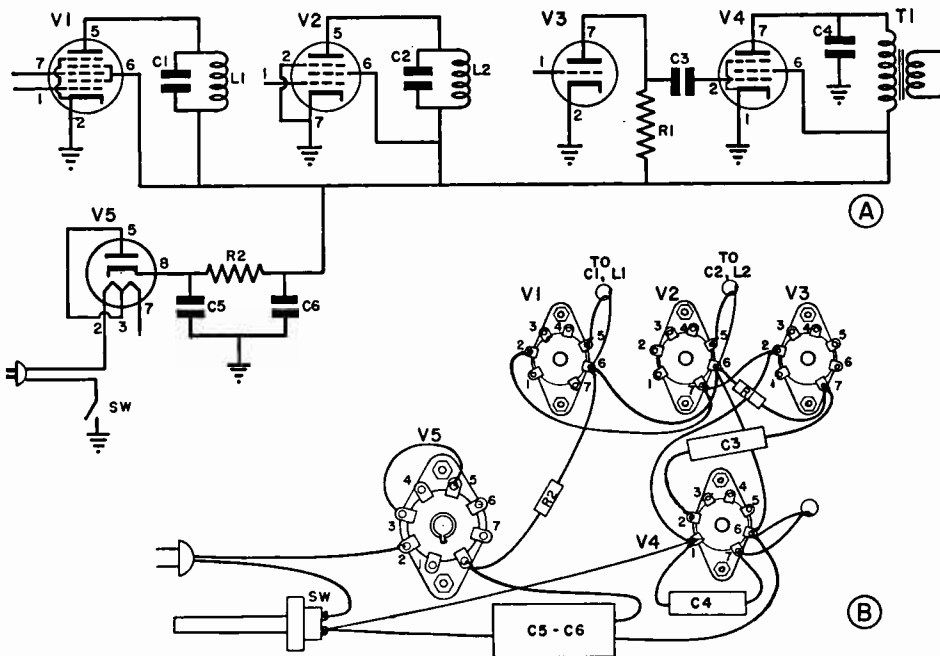

FIG. 1. The B supply circuit in an ac-dc receiver. A, the schematic; B, the pictorial.

With a power supply circuit like this one, there are many possibilities, and they must each be checked, one at a time.

When you have determined that the short is on the output side of the filter choke, the next step is to start checking the individual B+ circuits. Here is the procedure.

Check between terminal 2 of the voltage divider resistor and ground. If this reading is higher than that obtained at the output side of the filter choker, condenser C149A is shorted, or there is a short in the +325-volt line.

Next, check between terminal 4 and ground. If this reading is higher than that at terminal 3, start checking the parts connected to +225-volt line.

If the reading obtained between terminal 4 of the voltage divider and ground is lower than that obtained between terminal 3 and ground, by more than the normal resistance of the divider, then check the parts connected with the +160-volt line.

In this circuit, it is highly unlikely that a short this far down on the voltage divider would cause overheating of the 5U4 tube since resistor R228C has a relatively high value, 1400 ohms. You

might, however, have to use ohmmeter tests to locate the reason for failure to obtain voltage at terminal 4 of the voltage divider or at one of the points further down on the divider.

There are certain precautions that must be observed to obtain accurate meaningful results in ohmmeter tests. Let's examine these for a moment.

Always "balance" the ohmmeter properly before beginning tests. Though extreme accuracy is seldom required in continuity tests like those described above, it is convenient to be able to obtain exact readings without rebalancing the ohmmeter.

Always use a medium range of the ohmmeter. On the lowest ranges, the current in the ohmmeter circuit is high and there is danger of damaging certain critical components such as crystal diodes and transistors; also, it might be difficult to obtain positive indications as you approached the point where the short actually existed. On the higher ranges, most non-vtvm type instruments use higher voltage batteries for the top ohmmeter ranges. In checking the extreme sensitivity of the ohmmeter may lead to erroneous conclusions. Also the higher voltage may damage components. Consider the case of an ohmmeter using a 45-volt battery and the tran-

Introducing the New NRI Professional MODEL 12 Vacuum Tube Voltmeter

Best Quality at Its Price

This VTVM is a top performer among low-priced Vacuum Tube Voltmeters. It's accurate, good looking, easy to operate. It has a wide selection of ranges, is stable and dependable, light in weight, small and compact. Only because we buy these VTVM's in large quantities direct from a well-known instrument maker, are we able to offer this fine instrument at this low price.

The Advantages of A Vacuum Tube Voltmeter

Essentially, a VTVM uses the amplifying ability of vacuum tubes to increase greatly the sensitivity of the basic voltmeter. The NRI Professional VTVM, Model 12, uses a sensitive 400 microampere meter movement in a balanced dual triode bridge vacuum tube circuit, which results in a constant input impedance of 13 1/3 megohms on all dc voltmeter ranges. This means that you can ignore the loading effects of the dc voltmeter even when making measurements in critical radio and television circuits. Peak-to-Peak or AC rms volts and resistance are also measured with the sensitive circuit. The meter movement is electronically protected against reasonable overloads.

Provides Five Basic Types of Measurements

1. DC Volts—Five ranges, 0-1200 volts, provide for all basic dc measurements in Radio and Television. With High Voltage TV Probe (available at extra charge), dc range is extended to 30,000 volts. Voltmeter polarity switch eliminates reversing leads. For correct polarity just change polarity switch.
2. AV Volts—Five ranges, 0-1200 volts, cover power frequencies, and supersonic frequencies.
3. Peak-to-Peak AC Volts measure up to 3200 volts in five ranges. Maximum shunt capacity of input cable 67 mmfd.
4. Ohmmeter Measurements—Up to 1000 megohms in five overlapping ranges. This permits measurements of extremely small and large resistances. Tests condensers for leakage and opens. Low ohms scale for checking coil windings. One zero adjustment serves all five ranges.
5. Zero Center Scale—Shifts electrical zero of the dc voltmeter from left end of scale to center of scale in a jiffy. A very important type of

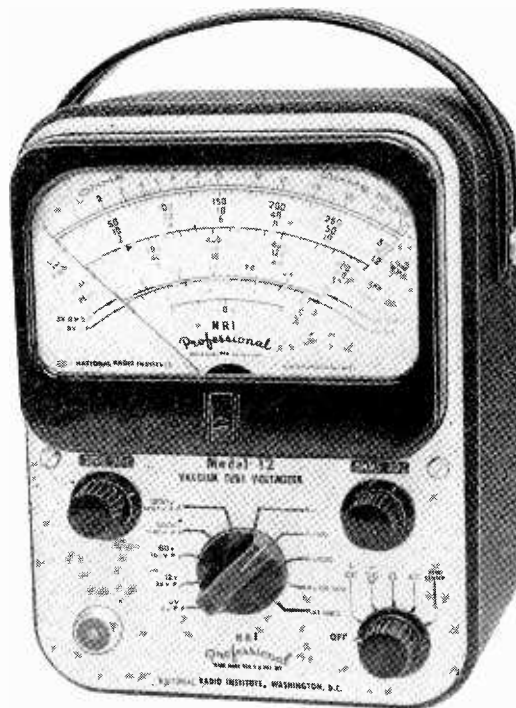

measurement in balancing FM and TV discriminator circuits, or in making measurements of unknown polarity. Five ranges 0 to ± 600 volts.

Output Measurements in connection with alignment. High dc sensitivity makes the Model 12 ideal for avc output measurements. DC blocking condenser on ac ranges permits measuring audio signal at plate of output tube.

Twenty-Five Separate Ranges

DC Volts	AC Volts	Ohms
0-3	0-3	0-1000 (10 ohms center scale)
0-12	0-12	100K (1,000 ohms center scale)
0-60	0-60	0-1 Megs (10,000 ohms center scale)
0-300	0-300	0-100 Megs (1 Meg center scale)
0-1200	0-1200	0-1000 Megs (10 Megs center scale)

PANEL: Brushed aluminum field, contrasting black deep-etched characters.

CASE: Metal, black ripple finish, with perspiration proof plastic handle, over-all size: 7¾" x 5½" x 3½".

METER: 400 microampere, double-jeweled D'Arsonval construction, ± 2%. Large 5½ inch meter—easy to read.

ACTUAL WEIGHT: 5¼ lbs. SHIPPING WEIGHT: 7 lbs. INCLUDES: Operating instructions and schematic diagram, AC-DC-Ohms probe, two 1½ volt flashlight cells.

TUBES: One 12AU7; two 6AL5 tubes.

POWER REQUIRED: Operates only on 50-60 cycles, 110-120 volts ac.

WARRANTY: Standard 90 day RETMA warranty.

Compare the NRI Professional VTVM with other instruments of this type. For quality and price you will find yourself coming back to the NRI VTVM as your best buy. We sincerely believe this instrument is unsurpassed in quality at this low price.

Universal Test Probe Included

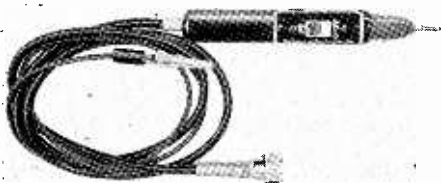

Universal test probe (above) included at no extra charge. Handy switch in handle. Throw in one direction for all AC volts, PEAK-TO-PEAK AC volts and Ohm measurements; in opposite direction for all DC volts measurements.

Optional Accessories

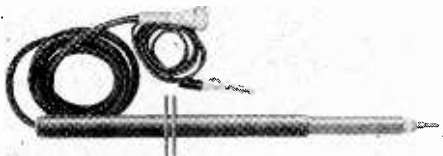

High Voltage TV Multiplier Probe

Illustrated above. Extends DC volts range to 30,000 volts for SAFE high-voltage TV measurements. Heavy-duty bakelite handle with two-inch high voltage barrier. Helical film-type cartridge multiplier resistor. Price, \$6.50.

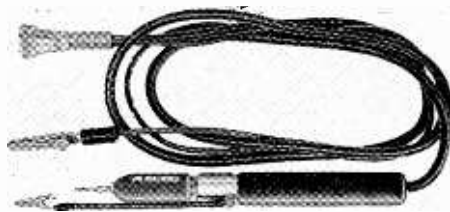

Crystal Detector High Frequency Probe

Illustrated above. Gives positive peak voltage values for sine-wave voltage up to a maximum peak value of 120 volts. Frequency range up to 250 mcs. Well-made probe, shielded lead and connector. Price \$9.50.

Sent express collect. Please use order blank below. (Personal checks should be certified to avoid 10 to 15 days' delay in shipment waiting for checks to clear.)

----- cut here -----

USE THIS BLANK TO ORDER YOUR VTVM

NATIONAL RADIO INSTITUTE 12
 3939 Wisconsin Ave., NW
 Washington 16, D. C.

I enclose \$..... (certified check, money order or bank draft) for which send me, by Railway Express, charges collect, the items I have indicated in the box on the right.

	Price	Write price here and add this column
One NRI Professional Vacuum Tube Voltmeter, Model 12, including Universal test leads, insulated alligator clip, and detachable isolating probe for dc measurements	\$45.00	
One Crystal Detector High Frequency Probe	9.50	
One High Voltage TV Multiplier Probe	6.50	
(If you live in Washington, D. C., add 2% D. C. Sales Tax)		
Total amount enclosed		

Name Student No.

Address

City State

Express Office



N.R.I. ALUMNI NEWS

Elmer E. Shue	President
Earl Oliver	Vice Pres.
John Babcock	Vice Pres.
William Fox	Vice Pres.
Joseph Stocker	Vice Pres.
Theodore E. Rose	Executive Secretary

NOMINATIONS FOR 1958

A year rolls by mighty quickly. It seems such a short time since the last election of National Officers of the NRI Alumni Association, but already we have to decide on the officers for 1958. Five are to be elected, the President and four Vice-Presidents.

First we will cast our ballots to nominate the candidates. To the two men receiving the largest number of votes for the office of President will go the honor of becoming the candidates for that office. The eight men receiving the greatest number of votes for the office of Vice-President will be the candidates for a Vice-Presidency.

Selection of candidates must be completed by August 25, 1957. To make sure your vote counts in the selection of candidates, mail your ballot well ahead of that date.

The votes will be tallied at National Headquarters. The names of the candidates nominated will be published in the October-November issue. From among the candidates nominated NRIAA members will cast their ballots for the President and four Vice-Presidents. The election ballots will be furnished members in the October-November issue.

This election is being conducted as provided in our Constitution, Article VI, quoted below:

1. *The election of the President and the Vice-Presidents shall be by ballot.*
2. *The President shall be eligible for reelection only after expiration of at least one year following his existing term of office, and when not a candidate for President, may be a candidate for any other office. Other officers may be candidates to succeed themselves, or for any other, but not more than one, elective office in the Association.*
3. *The election of officers shall be held in October of each year, on the day designated by the Executive Secretary, but not later than the twenty-fifth of the said month.*

4. *The Executive Secretary shall advise Members by letter, or through the columns of the National Radio News, on or before August first of each year that names of all nominees shall be filed in his office not later than August twenty-fifth following.*

5. *Each Member shall be entitled to submit, in writing, one nomination for each office, and the two nominees receiving the highest number of votes shall be the nominees for the office for which nominated.*

6. *The Executive Secretary, before placing any name on the ballot, shall communicate with each nominee, to ascertain his acceptance of the office, if elected. If such tentative acceptance is withheld, the eligible nominee having the next highest number of votes shall be the nominee for that office.*

7. *The Executive Secretary, on or before October first of each year, shall furnish Members a ballot listing the names of the nominees for each office.*

8. *No Member shall be entitled to vote if he is in arrears in the payment of dues.*

9. *Ballots, properly executed and valid according to the instructions plainly printed thereon, shall be returned to the Executive Secretary on or before midnight of October twenty-fifth of each year.*

10. *The Executive Secretary shall designate three Election Tellers from the staff of the Institute, who shall count the ballots and certify the results, together with the return of the ballots, to the Executive Secretary.*

11. *In the event of a tie vote for any office, the Executive Secretary shall cast the deciding ballot.*

12. *The nominee receiving the greater number of votes for the office for which nominated shall be declared by the Executive Secretary to be elected to that office, and notice of such election shall be forwarded in sufficient time, prior to January one, to permit such elected officer to enter upon the duties of said office on that date.*

Since a President may not succeed himself, Elmer Shue of Baltimore will vacate the office of the Presidency on December 31. As mentioned in previous issues of the National Radio-TV News, Mr. Shue has held various offices in the Baltimore Chapter — Treasurer, Vice-Chairman, Chairman, Librarian, and Sergeant-at-Arms, besides servicing on various committees—and has always welcomed the opportunity to serve the Baltimore Chapter in any way he could. Mr. Shue can now have the satisfaction of knowing that he has served faithfully not only his own Baltimore Chapter but the entire NRI Alumni Association as well.

The strongest contender for the Presidency this year is Howard Smith of Springfield, Mass. In fact, Mr. Smith almost won out over Mr. Shue last year. He is a past Vice-President, has previously been Vice-Chairman and Chairman of the Springfield Chapter, and is currently its Chairman. Because of his loyalty and his enthusiastic support of the Springfield Chapter and of the Alumni Association as a whole, it would be difficult to find a candidate better fitted for the office of the Presidency than Howard Smith.

The restriction against succeeding themselves in office does not apply to Vice-Presidents. Our current Vice-Presidents can therefore be re-elected. The present incumbents are F. Earl Oliver of Detroit, John Babcock of Minneapolis, William Fox of New York City, and Joseph Stocker of Los Angeles.

Other likely candidates for Vice-President are: Edwin Kemp, former Chairman and now Secretary of the Hagerstown Chapter; Joseph Dolivka, Chairman, Baltimore Chapter; Frank Skolnik, Chairman, Pittsburgh Chapter; and Jules Cohen, Secretary, Philadelphia-Camden Chapter. A word about the last-named: Jules Cohen came so close to being elected a Vice-President last year that here at National Headquarters we found it necessary to recount the votes for him twice, but he nevertheless lost out by just a hair's breadth. He is therefore one of the strongest candidates for Vice-President this year.

Other candidates to be considered are named under "Nomination Suggestions" on the next page. These men are listed to help members in choosing their candidates. It is entirely up to each member whom to vote for, provided only that you vote for a member of the NRIAA who is qualified to hold office in the Association. As customary, the names are suggested on the basis of geographical location in the United States and Canada.

To vote, simply fill in the Nomination Ballot and mail it to the Executive Secretary. Because of its importance, it is repeated here: Please be sure to mail your ballot in time to reach Washington by August 25.

Nomination Ballot

T. E. ROSE, *Executive Secretary*
NRI Alumni Association,
3939 Wisconsin Ave., N.W.,
Washington 16, D. C.

I am submitting this Nomination Ballot for my choice of candidates for the coming election. The men below are those whom I would like to see elected officers for the year 1958.

(Polls close August 25, 1957)

MY CHOICE FOR PRESIDENT IS

.....
CityState

MY CHOICE FOR FOUR VICE-PRESIDENTS IS

1.

CityState

2.

CityState

3.

CityState

4.

CityState

Your Signature

Address

CityState

Student Number

Nomination Suggestions

T. E. Berryhill, Pomerene, Ariz.
Gordon E. DeRamus, Selma, Ala.
Don Smelley, Cottondale, Ala.
Myron Rhodes, Little Rock, Ark.
A. R. Waller, Keo, Ark.
Joe. E. Stocker, Los Angeles, Calif.
Herbert Garvin, Los Angeles, Calif.
A. W. Blake, Denver, Colo.
Chas. Bost, Leadville, Colo.
Albrecht Koerner, Stamford, Conn.
Joseph Medeiros, Hartford, Conn.
Gary Robinson, Stamford, Conn.
Eric Woodin, Naugatuck, Conn.
Wm. F. Speakman, Wilmington, Del.
Jos. Certesio, So. Wilmington, Del.
George Cury, Washington, D. C.
Wm. G. Spathelf, Washington, D. C.
Glen G. Garrett, Bonifay, Fla.
Fred Sandfort, Winter Park, Fla.
Stephen J. Petruff, Miami, Fla.
W. P. Collins, Pensacola, Fla.
Raymond Marsengill, Atlanta, Ga.
R. R. Wallace, Ben Hill, Ga.
Joseph Bingham, Twin Falls, Idaho
H. C. Eskridge, Gannett, Idaho
Erwin Andrews, Batavia, Ill.
R. A. Holtzauer, Joliet, Ill.
Fred J. Haskell, Waukegan, Ill.
A. C. Adamson, Chicago, Ill.
Herbert Lausar, Chicago, Ill.
Walter Malina, Chicago, Ill.
Harold Bailey, Peoria, Ill.
Dick Michael, Hartford City, Ind.
Chase E. Brown, Indianapolis, Ind.
Paul Knapp, Evansville, Ind.
H. E. McCosh, Charles City, Iowa
E. C. Hirschler, Clarinda, Iowa
C. Hopkins, Hutchinson, Kans.
Wm. B. Martin, Kansas City, Kans.
K. M. King, Wichita, Kans.
Wm. Troxell, Lexington, Ky.
R. B. Robinson, Louisville, Ky.
L. H. Ober, Alexander, La.
R. J. Crochet, New Orleans, La.
Clarence Francois, New Orleans, La.
Walter Dinsmore, Machias, Maine
Harold Davis, Auburn, Maine
Ralph E. Locke, Calais, Maine
Herbert J. Blimline, Baltimore, Md.
Jos. Dolivka, Baltimore, Md.
Edwin Kemp, Hagerstown, Md.
G. O. Spicer, Hyattsville, Md.
Manuel Enos, Fall River, Mass.
Louis Crestin, Boston, Mass.
Howard B. Smith, Springfield, Mass.
Omer Lapointe, Salem, Mass.
John I. Babcock, Minneapolis, Minn.
Warren Schulze, St. Paul, Minn.
Arthur J. Haugen, Harmony, Minn.
William A. Zdrojkoski, Minneapolis, Minn.
F. Earl Oliver, Detroit, Mich.
Joseph Panigay, Detroit, Mich.
Harry R. Stephens, Detroit, Mich.
Robert Kinney, Detroit, Mich.
Patrick Van, Gulfport, Miss.
Robert Harrison, West Point, Miss.
Vernon Sayers, Kansas City, Mo.
A. Campbell, St. Louis, Mo.
C. W. Wichmann, Inverness, Mont.
Earl Russell, Great Falls, Mont.
V. S. Capes, Fairmont, Nebr.
Angelo Gillotti, South Omaha, Nebr.
C. D. Parker, Elko, Nev.
L. R. Carey, Elko, Nev.
Arthur Cornellier, Dover, N. H.
Geo. Stylianos, Nashua, N. H.
J. A. Stegmaier, Arlington, N. J.
George B. Karabin, Weehawken, N. J.
Claude W. Longstreet, Westfield, N. J.
C. Evan Yager, Albuquerque, N. Mex.
Solomon L. Ortiz, Raton, N. Mex.
Willy Fox, New York, N. Y.
John V. Dugan, Syracuse, N. Y.
Paul C. Perez, New York, N. Y.
Phil Spampinato, New York, N. Y.
Nelson M. Leverage, Poughkeepsie, N. Y.
James Outlaw, Greensboro, N. C.
Irvin Gardner, Saratoga, N. C.
Max J. Silvers, Raleigh, N. C.
Arvid Bye, Spring Brook, N. Dak.
Wilbur Carnes, Columbus, Ohio
H. F. Leeper, Canton, Ohio.
Edward Siegel, Cleveland, Ohio.
Byron Kiser, Fremont, Ohio
L. O. Marcear, Tulsa, Okla.
Emil Domas, Ritter, Oreg.
Folia T. Hall, Portland, Oreg.
Jules Cohen, Philadelphia, Pa.
Frank Skolnik, Pittsburgh, Pa.
Elmer E. Hartzell, Allentown, Pa.
Charles V. Commo, Philadelphia, Pa.
Frank Mendes, Providence, R. I.
James F. Barton, Greer, S. C.
Norman L. Thovson, Rapid City, S. Dak.
John Wenzel, Gettysburg, S. Dak.
Newell M. Comer, Tullahoma, Tenn.
A. V. Craig, Memphis, Tenn.
Oscar C. Hill, Houston, Texas
Norman A. Bird, San Antonio, Texas
N. G. Porter, Cedar City, Utah
M. S. Galloway, Portsmouth, Va.
Frank Chory, Norfolk, Va.
Thomas C. Heinsdale, Richmond, Va.
B. C. Bryant, Alburg, Vt.
C. R. Thompson, Vancouver, Wash.
Alfred Stanley, Spokane, Wash.
Albert F. Zahradnek, Auburn, Wash.
Carlton L. Santmier, Martinsburg, W. Va.
S. J. Petrich, Milwaukee, Wisc.
Harold Brown, Laramie, Wyo.
Charles A. Smith, Cheyenne, Wyo.
M. Martin, New Westminster, B. C., Canada
E. D. Smith, Winnipeg, Man., Canada
H. V. Baxter, St. John, N. B., Canada
W. F. Arseneault, Dalhousie, N. B., Canada
Donald Swan, Springhill, N. S., Canada.
John Taylor, Brantford, Ont., Canada
P. Fisk, Montreal, P.Q., Canada
Thos. Crooke, Saskatoon, Sask., Canada

Chapter Chatter

Hagerstown (Cumberland Valley) Chapter held its last meeting of the season in June, having suspended meetings during July and August.

Even at the June meeting, the heat was so severe and the number of members attending was so relatively small that it was decided to have a business meeting only. The business meeting was devoted mostly to the discussion of an annual banquet in the Fall. Members selected the first meeting of the Fall season, September 13, as the date on which to hold the annual banquet.

Following the banquet on September 13, the Chapter will meet on the second Thursday of each month, 8 P.M., at the YMCA, Hagerstown. NRI students and graduates in the Cumberland Valley are cordially invited to attend meetings either as guests or potential members. Write or telephone Secretary Edwin Kemp, 618 Sunset Ave., Hagerstown.

New York City Chapter has carried through with its usual heavy program of talks from among its members right up to the end of the current season, in spite of the hot weather. Tom Hull has continued his TV series by reviewing what has been covered to date and introducing troubles in the Chapter's TV set to show the effect of certain conditions. He also described multivibrators as used in TV circuits and outlined the operation and the wave shapes developed by the plate coupled and the cathode coupled multivibrators. Jim Eaddy gave a demonstration of testing TV picture tubes, using the "Nulife" CRT Tester. This was a particularly interesting demonstration.

Phil Spampinato outlined constructional details for building a 1000 cycle tone generator for use in testing the audio sections of radios, televisions, and amplifiers by signal injection. From the number of sheets of paper which appeared among the members and the taking of notes and the diagrams in evidence, it was apparent that this was a very timely topic and one that was enjoyed by all.

Willie Fox gave an accounting of some of his "tough dog" and unusual experiences in Radio troubleshooting. If you have never heard Willie telling about his experiences, you don't know what you've missed.

At an earlier meeting Mark Anthony, continuing his series on Radioclocks, related some of the hazards of running a small business alone. This was an impressive and enlightening discussion.

The Executive Committee, with reluctance, has

felt it necessary to raise the subject of an increase in dues because of the increased costs of running the Chapter. After discussing the problem at some length it was decided to leave the question open for the present.

Also discussed was a proposed "social evening" early in the coming Fall. It was decided to hold this social on October 17, thereby allowing plenty of time to make the necessary arrangements.

The June 20 meeting was the last for this season, since the Chapter suspends meetings during the summer months. In his letter notifying members about the June 20 meeting, Chairman Ed McAdams extended his best wishes to all members for an enjoyable, safe summer, and his hope that they would return in the fall with renewed vigor and enthusiasm for the Chapter meetings.

The Chapter meets on the first and third Thursday of each month at St. Marks Community Center, 12 St. Marks Place, New York City. The next meeting—the first of the Fall season—will be on September 19. All students and graduates in the New York City area are welcome to attend the meetings. Get in touch with Chairman Edward McAdams, 135 W. 90th St., New York 24, or Secretary Emil Paul, 6 Gateway, Bethpage, L. I., N. Y.

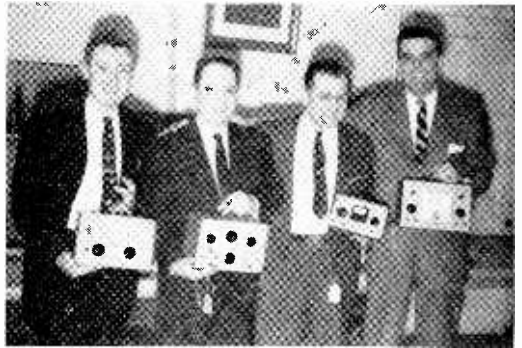

Guest-speakers at a meeting of the Philadelphia-Camden Chapter: Jim Daly, Service Manager, and Ed Stepler, Sales Manager, Almo Radio Company; Pete Pettie, Sales Manager, Winston Electronics; and Ernie Stuchell, Sales Representative, Winston Electric Company.

Philadelphia-Camden Chapter, not to be outdone by some of the other chapters, had its Spring Party on June 10.

First there was a short business meeting. This was followed by the showing of some service film from the Philco Corporation on their new portables and their 7L40 and 7L70 chassis. Then the party was on! According to Secretary Jules

Cohen there was plenty to eat and everybody had a lot of fun. From having been at several of these parties himself, your Executive Secretary can testify to the quantities of excellent food and how much fun there is at these parties. All the members look forward to them and they bring in a lot of members who don't attend the regular meetings too often, thereby giving all the members a chance to renew acquaintances.

At a former meeting the Chapter was host to guest-speaker Henry Lapinski, formerly Service Manager for the Motorola Corporation and now Service Manager for the new Hot Point TV in Philadelphia, who spoke on the Hot Point TV Portables. Mr. Lapinski gave an excellent talk and enlightened the members on how portables should be serviced. Schematics and service bulletins were given out to all members present.

Since publication of the June-July issue of National Radio-TV News, the Chapter reports the following new members, all of Philadelphia: Henry Heywood, graduate; Robert Riquet, graduate; Gregory Torries, Jr., graduate; Charles Ignarski, student; Joseph Schleener, student; and George Zauflik, student. Our warmest welcome to these newest members of the Philadelphia-Camden Chapter.

The Chapter decided to hold only one meeting in July and August, on the second Monday of each of those months. Beginning in September the regular meetings will be resumed on the second and fourth Mondays of each month at



Jim Daly demonstrating Winston's dynamic sweep circuit analyzer to Philadelphia-Camden Chapter.

the Knights of Columbus Hall, Tulip and Tyson Streets, Philadelphia. All NRI students and graduates in the Philadelphia-Camden area are cordially invited to come to the meetings as guests. To secure an invitation or get more information about the meetings, write or telephone Secretary Jules Cohen, 7124 Souder St., Philadelphia.

Pittsburgh Chapter, at its June meeting, was given a demonstration of the NRI Professional Signal Tracer by David Benes, who used a Philco radio receiver for demonstration purposes. This was followed by Thomas Shnader's talk on the various problems confronting the Radio-TV serviceman. Members found both the demonstration and the lecture instructive and interesting.

Members are busy planning a picnic for late in August. It is hoped and expected that this picnic will be well attended. Socials of this kind are not only a lot of fun but they enable the members and their families to get to know each other better. This in turn helps to maintain the interest and enthusiasm that are so necessary to the welfare of the Chapter.

All students and graduates in or near Pittsburgh are invited to attend the meetings, which are held at 8 P.M. on the first Thursday of each month at 134 Market St., Pittsburgh. The Chairman is Frank Skolnik, 932 Spring Garden Ave., Pittsburgh. The Secretary is William Roberts, 2521 Wenzell Ave., Pittsburgh.

New Orleans Chapter's members are continuing to bring troublesome sets to meetings for analysis by other members. This practice enables all the members to learn many short cuts and help-



Left, Henry Lapinski, Service Manager for Hot Point TV, Philadelphia, demonstrating a Hot Point TV portable. Right, Vern Fisher, Mr. Lapinski's assistant.

ful techniques in solving Radio-TV service problems.

At a recent meeting representatives of Bell Telephone presented films and lectures on the Sun-Battery, its operation and construction. The Chapter is making plans for more lectures and documentary films on various subjects related to Radio and Television principles.

NRI men in the New Orleans area who have not attended the meetings of the Chapter are missing an opportunity to add to their store of practical Radio-TV know-how. Even if you are not now a member you will be cordially welcomed at the meetings either as a guest or a potential member. The meetings are held at the home of Louis Grossman, 2229 Napoleon Ave., New Orleans, on the second Tuesday of each month. For more information about the Chapter and its meetings, get in touch with Chairman Patrick Boudreaux, 1015 Race St., or Secretary Oscar Hilding, 6225 St. Anthony St., New Orleans.

Detroit Chapter celebrated its last meeting of the season with a Stag Party at the Chry-Moto Club in Windsor, Ontario.

These stag parties are great fun. Usually there is a piano player who pounds out the old familiar tunes while the members sit around playing penny ante, kid and joke with each other, swap yarns about odd or humorous experiences they have had in the course of their Radio-TV servicing careers, and otherwise enjoy themselves. The evening customarily ends with a buffet supper. And what a supper! The food is well prepared and delicious—and there is always far too much. It is doubtful if any member ever eats breakfast on the following morning.

The Chapter has purchased a transistor kit, the assembly of which was delegated to Ellsworth Umbreit. At the meeting preceding the Stag Party Mr. Umbreit gave an excellent detailed explanation of the circuit and the precautions necessary in the construction of a transistor kit.

The Chapter will resume its regular meetings in September, on the second and fourth Friday of each month, 8 P.M., at St. Andrews Hall, 431 East Congress St., Detroit. Students and graduates in the Detroit Area who are not members are cordially invited to attend the meetings as guests. Write or telephone Chairman John Nagy, 1406 Euclid, Lincoln Park, or Secretary James Kelley, 1140 Livernois Ave., Detroit.

Minneapolis-St. Paul Chapter is now holding its meetings at the homes of members, as announced in the June-July issue of National Radio-TV News. This is being done chiefly because when a member has a set he is having trouble with, he can take it with him and won't have to worry about not having the proper test

equipment or parts to repair the set, nor is there any need to transport testing equipment as was necessary when meetings were held at the YMCA.

Since the adoption of this practice one meeting was held at the home of George Dixon. At this meeting, Chairman John Babcock led a discussion and study of transistors, which was followed by a quiz session that proved to be very interesting to the members. Ray Thompson of Amery, Wisconsin, won the door-prize, one of the new NRI VTVM Kits. The members then enjoyed a tasty snack.

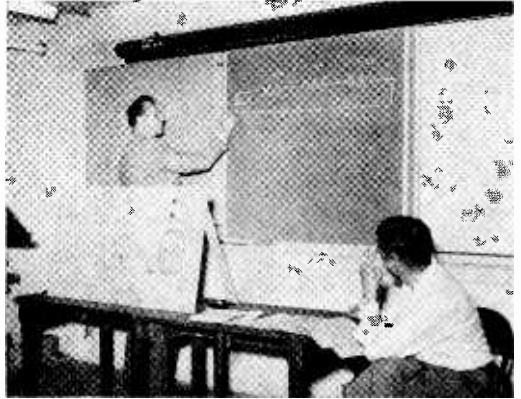

Joseph Gaze; Vice-Chairman of the Springfield Chapter speaking on "Mathematics of Series and Parallel Circuits".

The next meeting was held at Walt's TV, St. Paul. The Chapter was pleased to have Mr. Warren Schulze, manufacturer's representative, as guest-speaker at this meeting. Mr. Schulze gave an excellent talk on new test equipment, also demonstrated a new tube checker and vibrator checkers as well as a few other miscellaneous items.

Meetings are held on the second Thursday of each month. Students and graduates in the area who are not members of the Chapter will be cordially welcomed as guests. For full information about the meetings get in touch with Chairman John Babcock, 3157 32nd Ave., S., Minneapolis, Minn., or Secretary Paul Donatell, 939 Burr St., St. Paul.

Springfield (Mass.) Chapter has proof of the drawing power of its meetings. They recently had an NRI man as a guest who came all the way from North Adams, 72 miles from Springfield. He said it was too great a distance to travel for each meeting but expressed the hope that he would be welcome now and then. He was assured by the Chapter that he would be. Two more guests were present at this meeting, one from Hartford and the other one from Springfield.

At this same meeting Raymond Savers spoke on printed circuits. Ray is regularly employed as a photo-engraver. He had an excellent program during which he explained the process of making stencils for silk screen printing and even gave a demonstration of this printing process. He asked to be allotted time for more talks so that he can carry through on the various process of making printed strips. Lyman Brown, Technical Advisor to the Springfield Chapter, then took over the last half hour of the meeting for one of his question-and-answer sessions, and he had a lively time of it.

A later meeting was devoted to the showing of three films, one from Cornell-Dubilier on "Capacity Unlimited" and two from General Electric on the "Story of Light" and "Principles of Electricity." This was followed by the customary question-and-answer session, which is one of the regular events the members look forward to and take advantage of to solve their problems.



Raymond Savers delivering a talk on printed circuits to the Springfield Chapter.

As in former years the chapter has suspended meetings during July and August. However, the Chapter plans to hold its annual picnic one Sunday late in July or early August, to which all members are cordially invited.

Regular meetings will be resumed in September. They are held on the first and third Friday of each month, 7 P.M., at the U. S. Army Headquarters Building, 50 East St., Springfield. All NRI students and graduates in the Springfield area are welcome to attend the meetings as guests or potential members. Contact Chairman Howard Smith, 53 Bangor St., Springfield or Secretary Marcellus Reed, 41 Westland St., Hartford, Connecticut.

Milwaukee Chapter has adopted a program which promises to add considerably to its members practical knowledge of TV Servicing. From

among the membership a TV Sectional Analysis Group has been selected. The circuits on which members of this group are to deliver talks are assigned to the individual members by drawings from a hat. At each meeting one of the group then delivers a blackboard talk on the circuit he has drawn. He may use any method he chooses—oscilloscope, vtvm, etc., or simply describe theory.

Here is a list of the circuit analysis talks and the speakers to whom they have been assigned: Mr. Zudonyi, RF and Oscillator, delivered in June; Messrs. Werner and Rasmussen, Video I-F 7 Video Detector output, scheduled for July; Mr. Lasky, Sound I-F and Output, scheduled for August; Mr. Petrich, Power Supplies, scheduled for September; Messrs. Krauss and Betten-court, Horizontal Output, Damper and A.G.C., scheduled for October; Mr. Dallmann, Vertical Oscillator and Output, scheduled for November; and Mr. Smith, Horizontal Oscillator and Sync, scheduled for December.

These talks can be of great benefit to members in helping them to meet the every-day problems encountered in TV servicing. All members of the Chapter should make it a point to attend the meetings in order to avail themselves of the opportunity to get the help that these talks will give them. NRI students and graduates who are not members of the Chapter are also invited to attend the meetings either as guests or potential members, and it would be a good time to do so while these talks are going on. At the close of each meeting refreshments are provided through the courtesy of Philip Rinke.

The meetings are held on the third Monday of each month at the Radio-TV store and Shop of S. J. Petrich, 5901 W. Vliet St., Milwaukee. Students and graduates interested in attending meetings should get in touch with Chairman Erwin Kapheim, 3525 N. 4th St., Milwaukee, or Secretary Robert Krauss, 2467 N. 29th St., Milwaukee.

— n r i —

PLAQUE COMMEMORATING DEDICATION OF NRI'S NEW HOME PRESENTED BY SPRINGFIELD CHAPTER

During their recent visit to NRI, Howard Smith, Chairman, Springfield Chapter, and Lyman Brown Technical Advisor, presented NRI with a beautiful plaque which reads, "Commemorating the dedication of National Radio Institute New Home — 1957 — Springfield Mass. Chapter, NRIAA." The plaque was accepted by our Founder, J. E. Smith who, during the presentation, expressed his deep appreciation and sincere thanks to all Members of the Springfield Chapter.



GIVE

the



way



Here and There Among Alumni Members

Graduate H. J. Caldwell, Jr., West Covina, California, reports excellent earnings from his part-time Radio-TV business. His regular job is manager of a shoe

store located in Azuza.

— n r i —

NRI training proved valuable to Edward G. Ruppel of Lawrenceville, Illinois. Drafted into the Army when only half-way through his course, he was promoted to Regimental Chief Radio Repairman three months after receiving his first permanent assignment. He is a civilian once again working toward a degree in electrical engineering and managing a large TV and Appliance store at the same time.

— n r i —

Communications graduate Albert M. Walkup, Grand Junction, Colorado, now has his first class ticket and is working with the AEC as Assistant in Radio Communications.

— n r i —

Congratulations to 1930 grad Fred J. Haskell of Waukegan, Illinois, who recently celebrated his 89th birthday. Says he is still doing lots of Radio-TV repair work. We're sure many fellows would like to know your secret for really staying young, Fred.

— n r i —

Master Sergeant Martin L. Pluris, now retired, wanted to learn Radio and Television as a hobby but tells us it developed into a FULL, profitable spare-time business. He is making plans to open "Marty's Radio-TV Service" soon at his home in Aurora, Colorado.

INDEX

Article	Page
Editorial	2
NRI Holds "Open House"	3
Building a "Free Power" Receiver	7
Listen Americans!	11
Servicing Printed Circuit Receivers	12
Skyways Under Control	17
Our Cover	18
Technical Ramblings	19
Introducing the New Model 12 VTVM	22
Alumni News	24
Chapter Chatter	27
Here and There	31

Graduate Nelson D. English, Enrico, California, writes that immediately after completing his course in Professional Television Servicing, he applied for and landed a job as Electronic Instrument Mechanic with North American Aviation. Good work Nelson and another example of the ever-increasing opportunities for a man with ambition and aptitude for work in Electronics.

— n r i —

Captain Warren P. Hoover, USAF, a graduate of 1952, drops us a line from Manila Air Station, Philippines, where he is assigned as Chief of the Communications Division. Captain Hoover is also an active "ham" and member of MARS, ARRL and AFCEA.

— n r i —

Otis L. Reynolds of Charlotte, N. C., reports a going part-time business in addition to his full-time work with Western Electric. Says that before he enrolled he was a time-keeper in a textile mill.

— n r i —

Graduate John M. Fornari, Homer City, Pa., is a maintenance supervisor for the Rochester and Pittsburgh Coal Co. He tells us they use radio communication to control the operation of haulage locomotives and finds his NRI training helpful in the maintenance of this equipment.

— n r i —

Jean Geci, a Montreal, Canada, Graduate is now in charge of the Electronic Department, Sears Limited. He services Klichograph—an electronic engraving machine—for the territory of Eastern Canada.

NATIONAL RADIO-TV NEWS
3939 Wisconsin Ave., N.W. Washington 16, D. C.

Second-class mail
privileges authorized
at Washington, D. C.

Mr Francis H Fingado
1653 California St
Denver 2 Colo

25236-G

4A